



RECYFIX[®] MONOTEC

Monolithic drainage system
with high retention volume.

NEW



My benefits with the **RECYFIX®MONOTEC**:

„With this channel, I'm on the safe side. It is lightweight, corrosion-free and particularly sturdy. Therefore, I save costs and my customer is satisfied.“

+



simple installation, low costs

+



corrosion-free and durable

=



My benefit:
Cost savings

RECYFIX® MONOTEC **NEW**

Monolithic drainage system for heavily frequented traffic areas.

Lightweight for easy, fast and low-cost installation

- maximum stability with minimum weight
- significantly lighter than channels made of mineral material
- especially easy transport and processing



1 m 100 NS channel = 7,8 kg
1 m 200 NS channel = 16,2 kg



Fast installation



Simple processing



Easy transport

RECYFIX® - corrosion-free and particularly sturdy

- High-Tech-Material from renowned Plastic Research Institute
- permanently resistant to frost, de-icing salt and UV light
- particularly durable even with frequent traffic

100% corrosion free



100% corrosion-free, especially in cases of frost and de-icing salt

RECYFIX® MONOTEC **NEW**

Monolithic drainage system for heavily frequented traffic areas.

1 Requirements

Monolithic drainage channels in traffic areas must:

- be permanently corrosion-resistant
- be secure against vandalism
- be maintenance-free and drain reliably
- satisfy aesthetic demands

2 Application areas

- Parking areas
- Market places, public spaces
- School playgrounds
- Residential areas
- Gas stations
- Traffic areas in trade and industry

3 Solution

Therefore, RECYFIX MONOTEC channels are especially suitable for draining such surfaces:

- Lightweight and easy processing for cost-effective installation
- Channel made of specially resistant modified polypropylene
- Leak-proof and chemical-resistant
- Sturdy and unbreakable
- Very quick to install





Installation in asphalt surface



Installation in concrete surface



Installation in paving surfaces



Particularly resistant to dynamic forces



Ideal for heavily-trafficked areas

The benefits of the **RECYFIX®** MONOTEC **NEW**

100% corrosion free

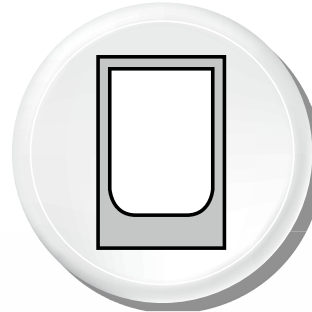

one piece channel

- vandal proof
- easy, very few system components

= safety



high hydraulic capacity

- optimised inlet surface with FIBRETEC design
- high volume through slim channel construction

= safety



low weight ensures easy handling on site

- significantly lighter than channels made of mineral material
- especially easy transport and fast installation

= Cost savings

Further details on page 3!



Fast installation



Easy transport



Simple processing



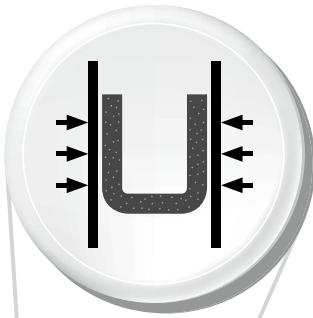

unbreakable

- elastic and especially resistant material (PP)
- resistant in daily use to traffic volume and temperature differences

= safety

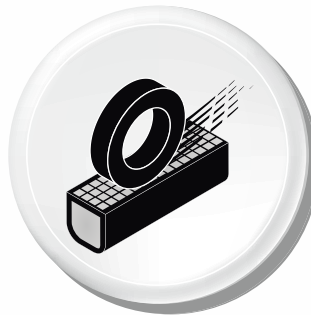

monolithic channel for maximum stability

- Channel and grating = one part
- Continuously withstands the highest traffic loads

= safety

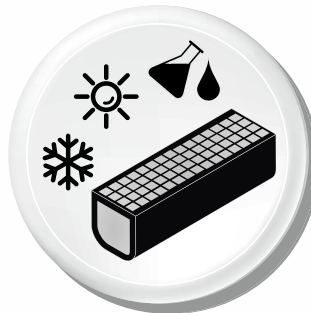

high resistance

- high resistance to frost, de-icing salt and UV light
- withstands high temperature differences
- chemical-resistant

= Durability



low maintenance

- easy cleaning by rinsing through the inspection box
- durable high-quality appearance

= Cost savings

RECYFIX® MONOTEC **NEW**

Optimal hydraulic capacity through slim design.

The RECYFIX MONOTEC channel is made of highly resistant and unbreakable polypropylene. Therefore, a particularly slender design is possible which has a positive effect with regard to drainage capacity. The smallest model, with a nominal width of 100 mm and a height of 230 mm, already achieves a drainage cross-section of 190.5 cm². Monolithic channels, made from other materials, must have much thicker sidewalls which significantly reduces the drainage cross-section.

The RECYFIX MONOTEC Channel range consists of 3 heights with a nominal width of 100 mm and one model with a nominal width of 200 mm. Long-term practical tests and computer-aided simulations lead to the same result: The RECYFIX MONOTEC accumulates heavy rainfall, provides a sufficient backwater reserve and drains large surfaces safely and reliably.



Enormous Volume

- channel reliably takes in heavy rain
- more area per channel meter can be drained

RECYFIX® MONOTEC

Nominal size	Height	Drainage cross-section		Volume/Channel
100 mm	230 mm	190.5 cm ²		19.1 l
100 mm	280 mm	245.5 cm ²		24.6 l
100 mm	380 mm	355.5 cm ²		35.6 l
200 mm	450 mm	746.1 cm ²		74.6 l

Maximum hydraulic capacity

The fiber-reinforced polypropylene material enables a slim channel design. As a result, a maximum hydraulic capacity is achieved.



NW 100, Type 230



NW 100, Type 280



NW 100, Type 380



NW 200, Type 450



NW 200, Type 450

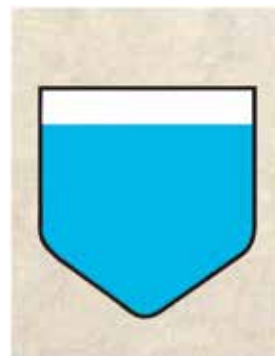

Lower drainage capacity, up to 45%, with monolithic channels made from other materials

FIBRETEC® slotted grating: Proven to make progress

In 2010, HAURATON invented the FIBRETEC slotted grating. This grating is specially designed for maximum hydraulic performance. Optimized inlet radii ensure that the largest amount of water is led into the channel within the shortest time. More than one million channels sold expresses its great popularity. Deliberately, the design has now been transferred to the RECYFIX MONOTEC. Along with the enormous volume of the channel, a product with the highest hydraulic demands has emerged - the perfect combination of water intake, retention and drainage.



Testing at HAURATON Hydraulic Center in Budapest

RECYFIX® MONOTEC **NEW**

Monolithic drainage system for heavily frequented traffic areas.

RECYFIX MONOTEC channels meet the requirements of DIN EN 1433 and are suitable for the following load classes:



**Category C 250,
Load Class 250 kN**



**Category D 400,
Load Class 400 kN**

If in doubt, always select the higher class.

1

RECYFIX MONOTEC channels made of modified polypropylene, according to DIN EN 1433, CE-conform.

2

Trash box made of galvanized steel with pipe connection possibility DN 200. Removable grating made of modified polypropylene for access to channel system.

3

Connection plate for flexible connection of different channel types with the trash box and closing cap for the closing of trash box.

4

End caps for channel start/channel end (DN 100).

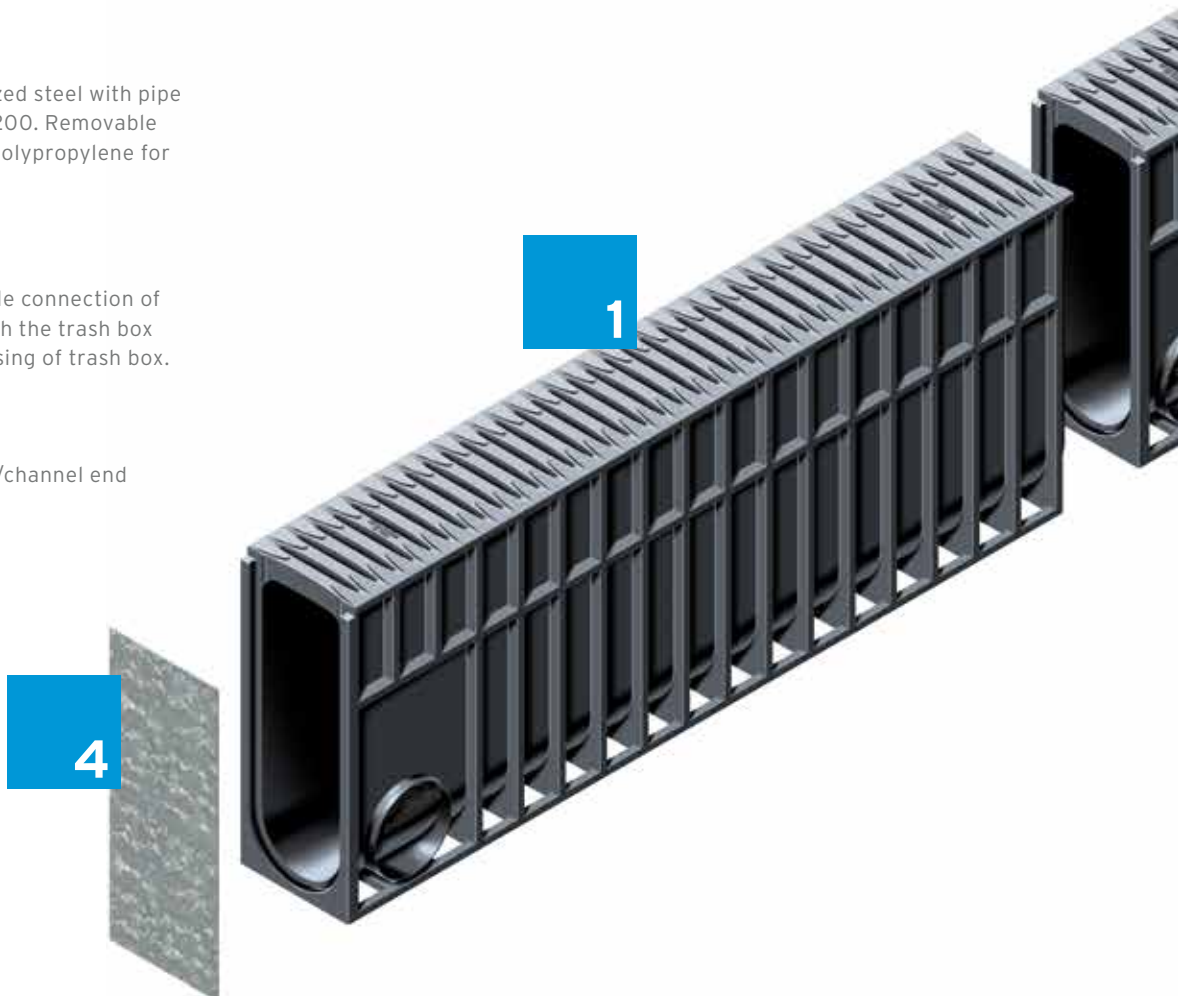

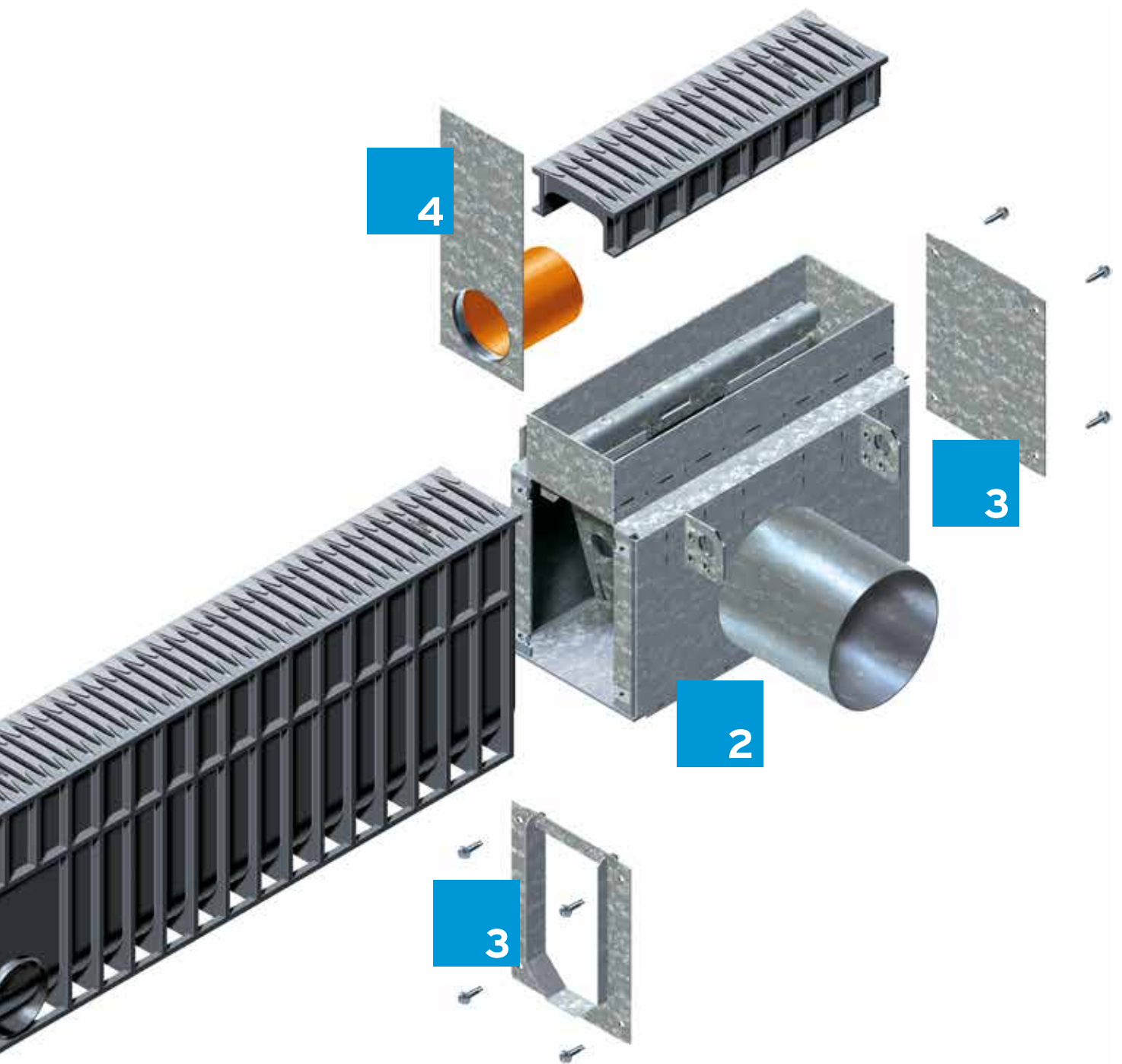

RECYFIX® MONOTEC Step Fall **NEW**

Reliable hydraulic performance for channel runs with a stepped slope.

Installation with a stepped slope.

When RECYFIX MONOTEC channels are laid to a stepped construction, an artificial slope is created using channels of different heights. RECYFIX MONOTEC step fall adapters are used at the transition from one level to the next. They bridge the difference in height, ensuring that the water drains away smoothly.

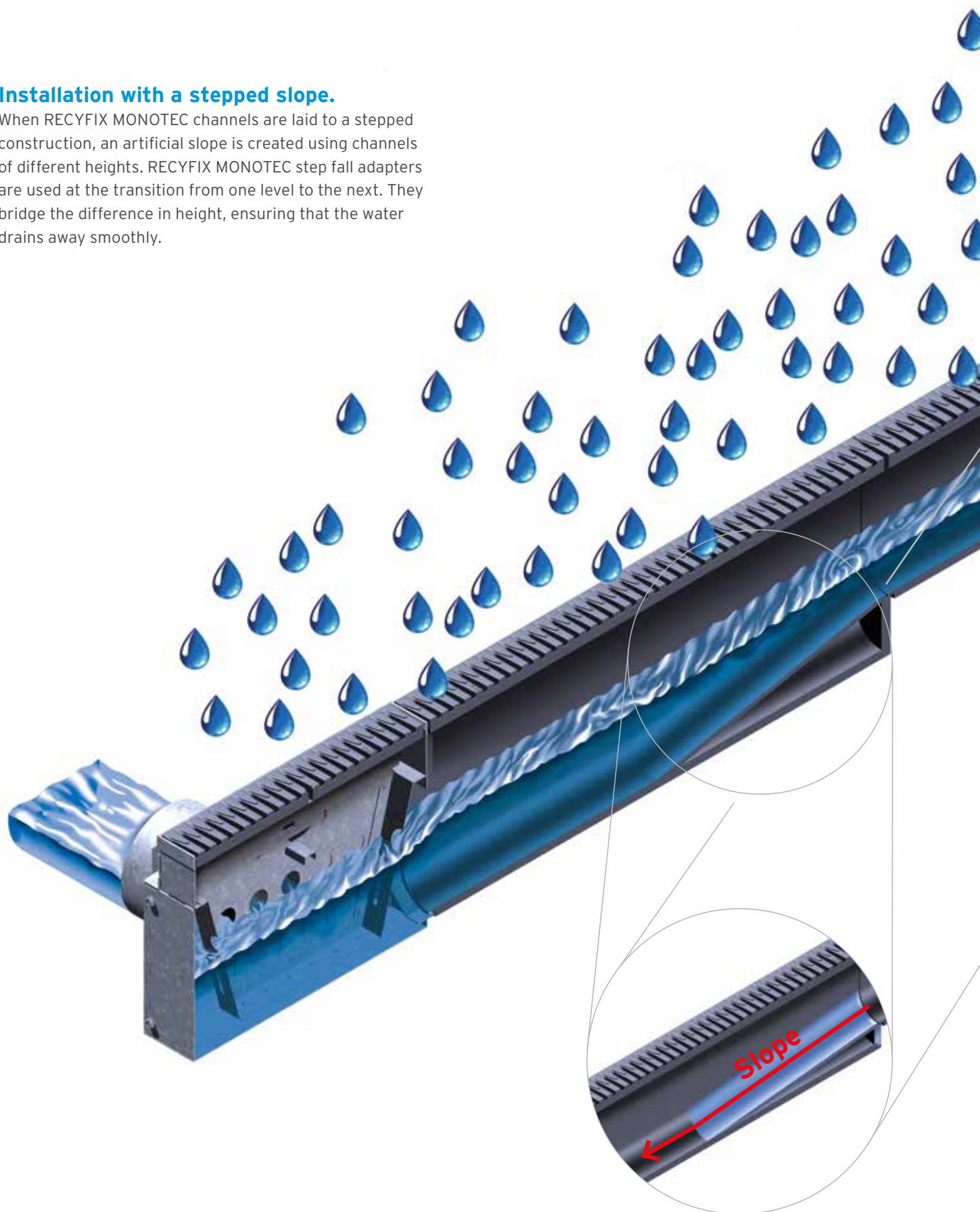

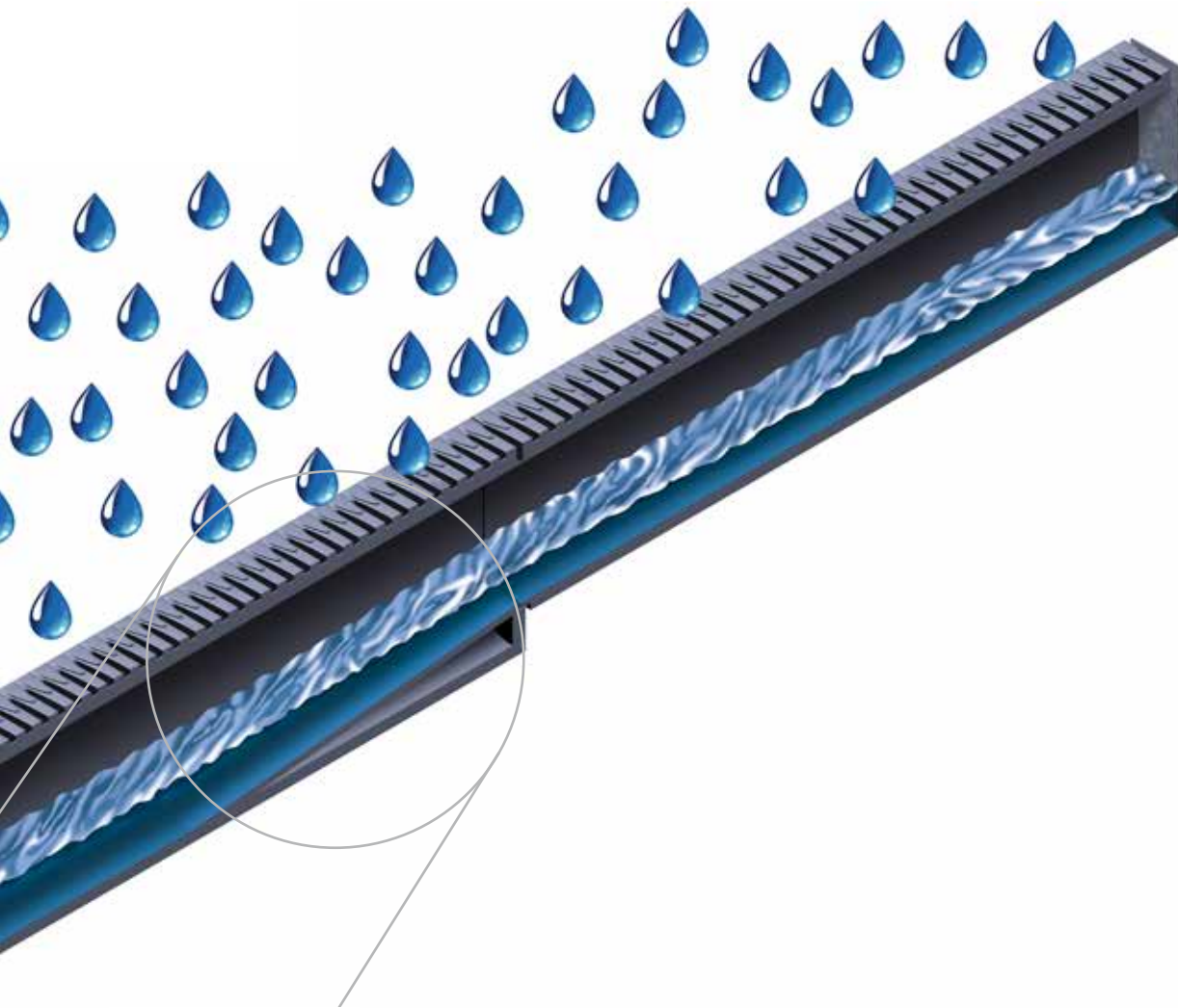

RECYFIX® MONOTEC Step Fall Adapter, black, for channel runs with step fall



Step Fall Adapter for transition from type 230 to 280



Step Fall Adapter for transition from type 280 to 380

RECYFIX® MONOTEC Channels 100:

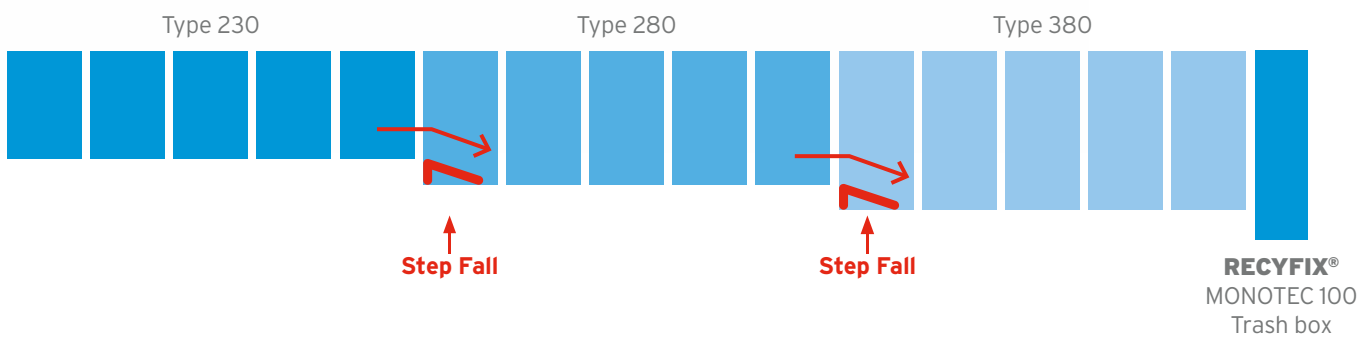

RECYFIX[®] MONOTEC 100 **NEW**

Monolithic channel

RECYFIX[®] MONOTEC 100, class D 400

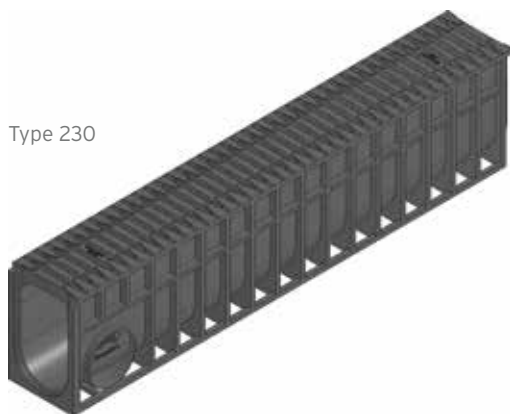

Type 230

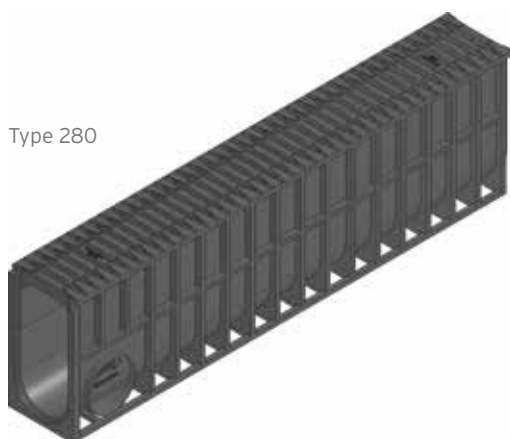
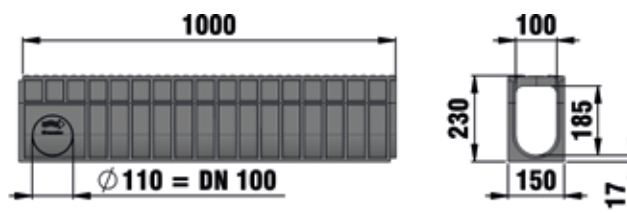

Type 280

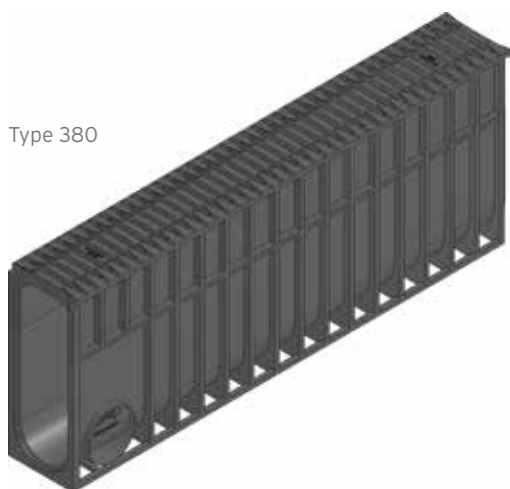
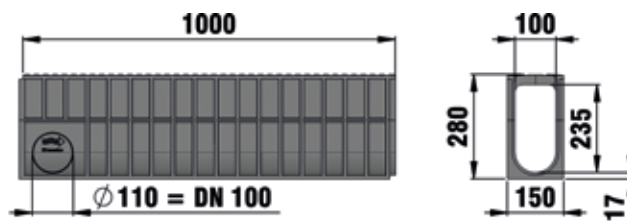

Type 380

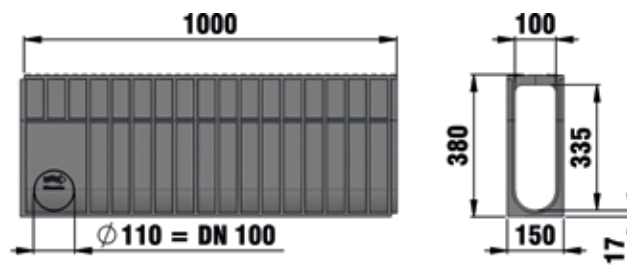

	Length mm	Width mm	Height mm	Intake cross-sect. cm ² /m	Drainage cross-sect. cm ²	Weight kg	Item No.
Type 230	1000	150	230	372	190,5	7,85	36000
Type 280	1000	150	280	372	245,5	8,63	36005
Type 380	1000	150	380	372	355,5	10,25	36015

RECYFIX[®] MONOTEC 100 **NEW**

Accessories

Trash box



Trash box with galvanised bucket

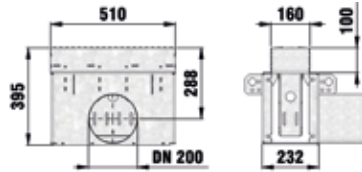

Technical drawing, trash box with galvanised bucket



Connection plate with screw set, galvanised, channel type 230



Closing cap with screw set, galvanised

	Length mm	Width mm	Height mm	Weight kg	Item No.
Trash box with galvanised bucket	510	160	395	-	36045
Looking handle with screw for protection against vandalism	-	-	-	-	36098
Connection plate with screw set, galvanised, channel type 230	-	216	283	-	36032
Connection plate with screw set, galvanised, channel type 280	-	216	283	-	36037
Connection plate with screw set, galvanised, channel type 380	-	216	283	-	36047
Closing cap with screw set, galvanised, for trash box/inspection box	-	216	283	-	36023

All trash and inspection boxes are factory-made with the end face open to enable a modular use for all application situations:

- Option 1: one-sided channel connection: You will need 1 connection plate with the same channel height (= same type) and an closing cap.
- Option 2: two-sided channel connection: You will need 2 connection plates with the same channel height (= same type).

RECYFIX® MONOTEC 100 **NEW**

Accessories

Inspection box



Inspection box

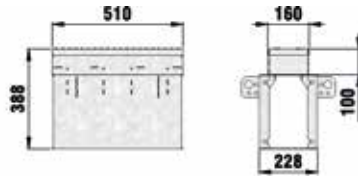

Technical drawing,
inspection box



Connection plate with
screw set, galvanised,
channel type 280



Closing cap with
screw set, galvanised

	Length mm	Width mm	Height mm	Weight kg	Item No.
Inspection box	520	160	388	-	36035
Looking handle with screw for protection against vandalism	-	-	-	-	36098
Connection plate with screw set, galvanised, channel type 230	-	216	283	-	36032
Connection plate with screw set, galvanised, channel type 280	-	216	283	-	36037
Connection plate with screw set, galvanised, channel type 380	-	216	283	-	36047
Closing cap with screw set, galvanised, for trash box/inspection box	-	216	283	-	36023

All trash and inspection boxes are factory-made with the end face open to enable a modular use for all application situations:

- Option 1: one-sided channel connection: You will need 1 connection plate with the same channel height (= same type) and an closing cap.
- Option 2: two-sided channel connection: You will need 2 connection plates with the same channel height (= same type).

RECYFIX[®] MONOTEC 100 **NEW**

End caps



End cap closed, galvanised, type 230



End cap with horizontal UPVC-outlet DN 100, galvanised, type 280

	Length mm	Width mm	Height mm	Weight kg	Item No.
End cap closed, galvanised, type 230	-	150	225	0,5	36080
End cap closed, galvanised, type 280	-	150	275	0,6	36082
End cap closed, galvanised, type 380	-	150	375	0,8	36086
End cap with horizontal UPVC-outlet DN 100, galvanised, type 230	-	150	225	-	36090
End cap with horizontal UPVC-outlet DN 100, galvanised, type 280	-	150	275	-	36092
End cap with horizontal UPVC-outlet DN 100, galvanised, type 380	-	150	375	-	36096

Further accessories

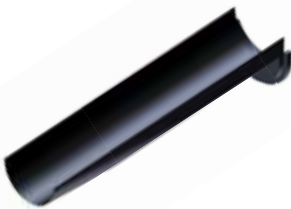

Step Fall Adapter for step slope, from type 230 to 280



Step Fall Adapter for step slope, from type 280 to 380

	Length mm	Width mm	Height mm	Weight kg	Item No.
Step Fall Adapter for step slope, from type 230 to 280	510	125	112,5	0,7	36070
Step Fall Adapter for step slope, from type 280 to 380	510	125	162,5	0,8	36071

RECYFIX[®] MONOTEC 200 **NEW**

Monolithic channel

RECYFIX[®] MONOTEC 200, class D 400

Type 450

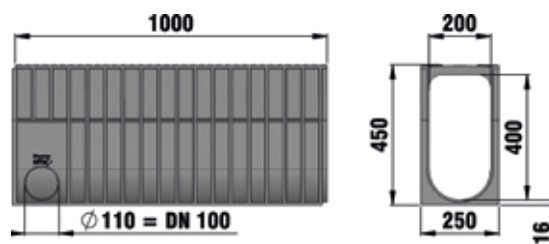

	Length mm	Width mm	Height mm	Intake cross-sect. cm ² /m	Drainage cross-sect. cm ²	Weight kg	Item No.
Type 450	1000	250	450	656	746,1	16,2	36215

RECYFIX® MONOTEC 200 **NEW**

Accessories

Trash box

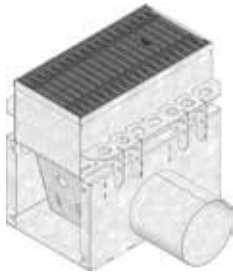

Trash box with galvanised bucket

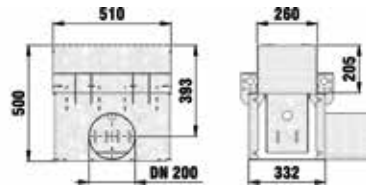

Technical drawing, trash box with galvanised bucket



Connection plate with screw set, galvanised, channel type 450



Closing cap with screw set, galvanised, for trash box/inspection box

	Length mm	Width mm	Height mm	Weight kg	Item No.
Trash box with galvanised bucket	510	260	500	-	36245
Looking handle with screw for protection against vandalism	-	-	-	-	36298
Connection plate with screw set, galvanised, channel type 450	-	316	283	-	36247
Closing cap with screw set, galvanised, for trash box/inspection box	-	316	283	-	36223

All trash and inspection boxes are factory-made with the end face open to enable a modular use for all application situations:

- Option 1: one-sided channel connection: You will need 1 connection plate with the same channel height (= same type) and an closing cap.
- Option 2: two-sided channel connection: You will need 2 connection plates with the same channel height (= same type).

RECYFIX® MONOTEC 200 **NEW**

Accessories

Inspection box



Inspection box

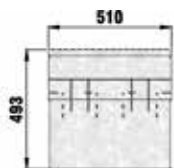

Technical drawing, inspection box

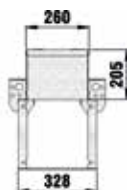

Connection plate with screw set, galvanised, channel type 450



Closing cap with screw set, galvanised, for trash box/inspection box

	Length mm	Width mm	Height mm	Weight kg	Item No.
Inspection box	510	260	493	-	36235
Looking handle with screw for protection against vandalism	-	-	-	-	36298
Connection plate with screw set, galvanised, channel type 450	-	316	283	-	36247
Closing cap with screw set, galvanised, for trash box/inspection box	-	316	283	-	36223

All trash and inspection boxes are factory-made with the end face open to enable a modular use for all application situations:

- Option 1: one-sided channel connection: You will need 1 connection plate with the same channel height (= same type) and an closing cap.
- Option 2: two-sided channel connection: You will need 2 connection plates with the same channel height (= same type).

End caps



End cap closed, galvanised, type 450



End cap with horizontal UPVC-outlet DN 150, galvanised, type 450

	Length mm	Width mm	Height mm	Weight kg	Item No.
End cap closed, galvanised, type 450	-	250	445	1,7	36286
End cap with horizontal UPVC-outlet DN 150, galvanised, type 450	-	250	445	-	36296