

RECYFIX® PLUS X

STABLE DRAINAGE.

WITH A PROTECTIVE EDGE AND ATTRACTIVE DESIGN.



AT A GLANCE

- ✓ Loading category D 400, certified to EN 1433
- ✓ Internal width 100mm to 300mm
- ✓ Light and robust
- ✓ Easy and quick to install



RECYFIX®PLUS X

STABLE DRAINAGE.

WITH PROTECTIVE EDGE AND ATTRACTIVE DESIGN.

INNOVATIVE AND ENVIRONMENTALLY FRIENDLY

RECYFIX®PLUS X channels are made from PE-PP and are fully recyclable. Because they are light, RECYFIX®PLUS X channels are easy to transport and to install.

The system meets the most severe requirements in terms of robustness and functionality. RECYFIX®PLUS X channels have been developed for use in areas with higher traffic flows. The channels edges are protected by steel angle housing. RECYFIX®PLUS X provides you with a complete range including all the accessories you need.

RECYFIX®PLUS X channels were developed in partnership with a renowned recycled plastic research institute. Using computer-based simulations, very robust structures re-

inforced by means of ribs were designed - they are much lighter than traditional channels made from materials such as rock and stone and are also very functional and robust.

RECYCLED PE-PP MATERIAL

RECYFIX®PLUS X channels are made from recycled PE-PP materials. What sets them apart from other channels is their high chemical resistance to freezing, to the salts that are used to de-ice roads and to UV rays. They are also environmentally neutral and impermeable.



Polygonal installation

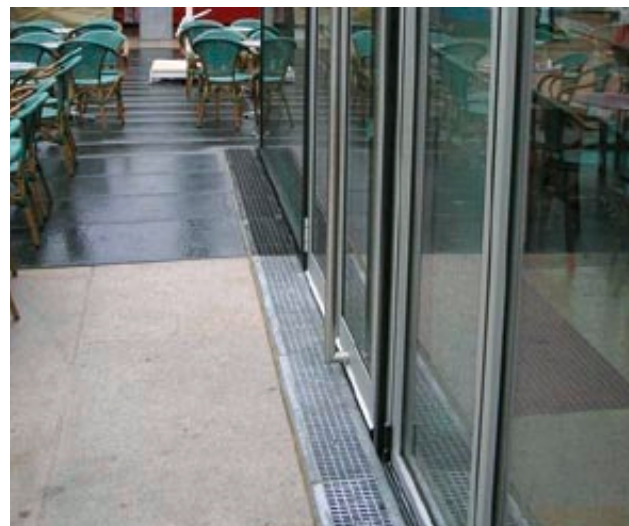

Installation on terraces

REQUIREMENTS

The choice of a drainage system is determined by various criteria - i.e. constraints, be they technical, to do with transport or budget-related, which themselves are determined by what kind of environment the system is intended for. Whether the system is being installed in an area with paving stones, in a patio, in a public park, or in car parks, pedestrian zones, or in streets with vehicular traffic, the water-drainage systems used must satisfy all of the demands placed upon them, both by pedestrian and vehicular traffic. Surface water must be drained very effectively but must also be carried away quickly using reliable means.

SOLUTIONS

The channels in the RECYFIX®PLUS X range have galvanised steel angle housings, a channel body made of PE-PP and are certified according to EN 1433 for loadclass D 400. The PE-PP channels in the RECYFIX®PLUS X range are light but unbreakable and are supplied in nominal widths from 100mm up to 300mm. They are highly resistant against freezing and road salt resistant as well as being easy to install linearly on the construction site.

APPLICATIONS

The channels can be used in all areas with paving stones, for patio areas, in public parks, in pedestrian zones, and also in car parks and in industrial and trading estates, etc.



In areas with vehicular traffic, such as streets and car parks



In industrial settings

RECYFIX® PLUS X

STABLE DRAINAGE.

WITH A PROTECTIVE EDGE AND ATTRACTIVE DESIGN.

RECYFIX® PLUS X channels are certified according EN 1433 and can be installed in areas in which the following loading capacities can be expected:





**CATEGORY D 400,
LOAD CLASS 400 KN**

GENERAL INSTRUCTIONS FOR THE USE OF THE CHANNELS:

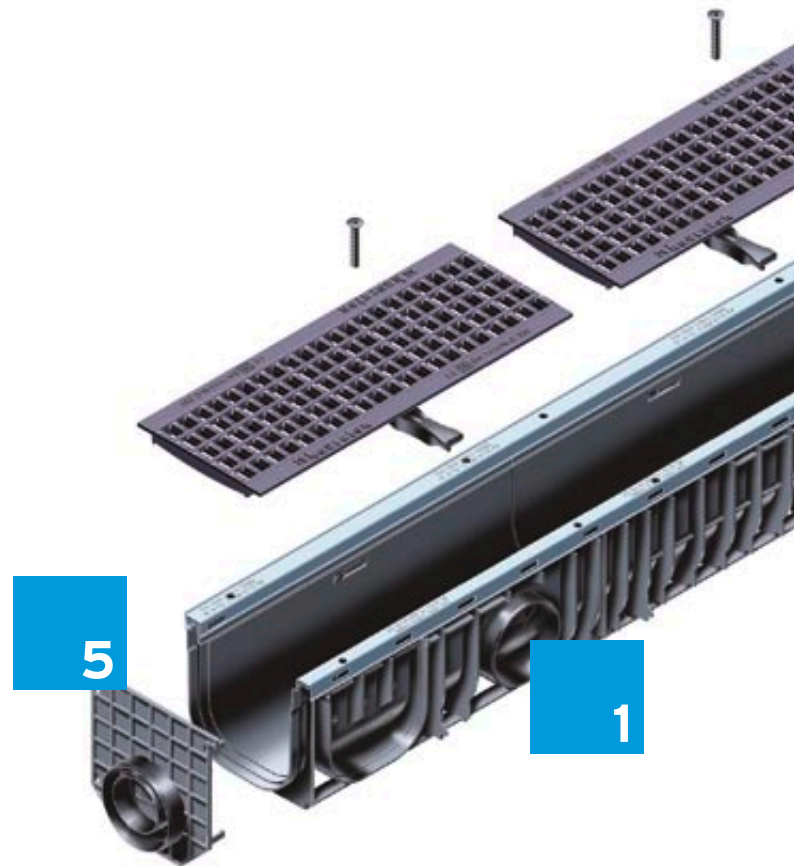
- The channels installation advices provided in the "Installation advices manual" are for information purposes only. Their provision does not mean that project engineers can dispense with efforts to find laying solutions suitable for sites and the specific constraints encountered on the ground.
- Correct flow directions must be complied with (see arrows on the outsides of channels).
- Surface paving must be 3 mm to 5 mm higher than the level of the channel top level.
- Expansion joints must be correctly positioned, in order to completely counteract horizontal expansion forces.
- Insert the gratings of the channels to ensure that the channels are stable before pouring second-stage concrete:
- Detailed installation advices can be downloaded from our website www.hauraton.com. These instructions are updated on a regular basis.

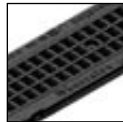

GRATING FOR RECYFIX® PLUS X CHANNELS

	GUGI-Ductile iron mesh gratings*	Ductile iron gratings*
Load class		
A 15		
B 125		
C 250		
D 400	100, 150, 200, 300	300

* The measurements listed are internal widths.

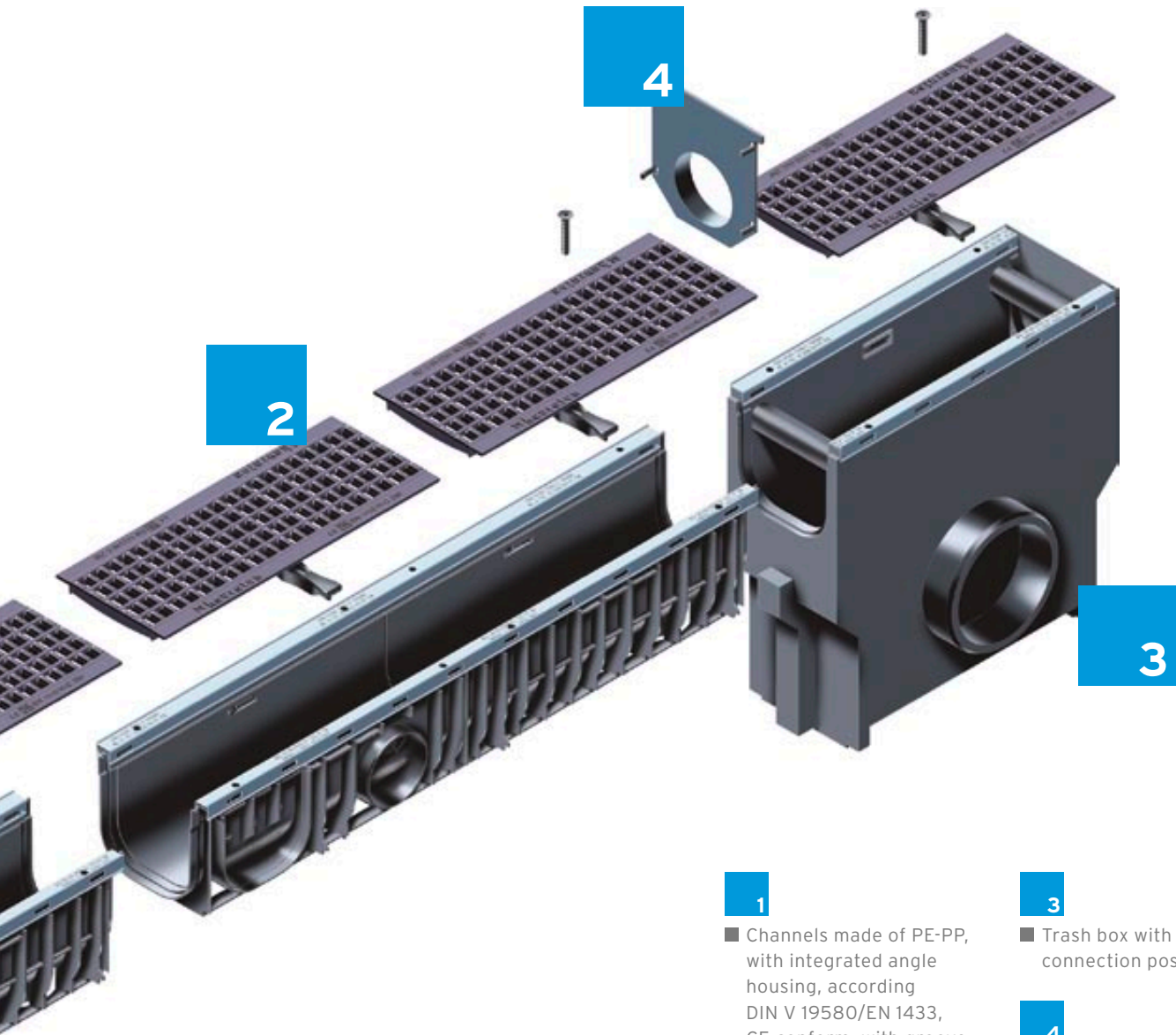

1

■ Channels made of PE-PP, with integrated angle housing, according DIN V 19580/EN 1433, CE-conform, with groove and tongue connection for exact installation

2

■ Numerous grating options, for example GUGI-Ductile iron mesh gratings

3

■ Trash box with pipe-connection possibilities

4

■ End cap with outlet

5

■ End cap

NORM EN 1433

All RECYFIX®PLUS X channels comply with European standard EN 1433 by fulfilling its requirements and they all carry the CE quality mark.

A FULL RANGE

RECYFIX®PLUS X channels are available in different heights and widths. They can be connected to other accessories in the channels bottom, the side-walls or from the front side. You have a choice between several ductile iron gratings depending on the type of paving used and the load class. Also available in the range are trash boxes with mud bucket, end caps and end caps with vertical outlet.



Parking

RECYFIX®PLUS X 100

RECYFIX®PLUS X 100 - combi article, class D 400

Type 01 with GUGI-ductile iron mesh grating, cl. D 400, locked, 1 m

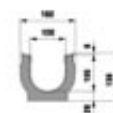
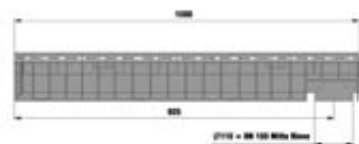

	Length mm	Width mm	Height mm	Drainage cross- sect. cm ²	Intake cross- sect. cm ² /m	Weight kg	Article No.
Type 01 with GUGI-ductile iron mesh grating, cl. D 400, locked, 1 m	1000	160	139	93	440	10,5	42070
Type 010 with GUGI-ductile iron mesh grating, cl. D 400, locked, 1 m	1000	160	187	142	440	11,2	42075
Type 0105 with GUGI-ductile iron mesh grating, cl. D 400, locked, 0,5 m	500	160	139	93	440	5,2	42077
Type 01005 with GUGI-ductile iron mesh grating, cl. D 400, locked, 0,5 m	500	160	187	142	440	5,6	42078

RECYFIX®PLUS X 100 - Accessories



Trash box with GUGI-ductile iron mesh grating, cl. D 400, locked, 0,5 m



Foul air trap DN 100, outside



Foul air trap DN 100, inside

	Length mm	Width mm	Height mm	Weight kg	Article No.
Trash box with GUGI-ductile iron mesh grating, cl. D 400, locked, 0,5 m	500	158	424	7,3	42079
Foul air trap DN 100, outside	-	-	-	0,4	961
Foul air trap DN 100, inside	-	-	-	0,2	40290
Foul air trap, vertical, DN 100	-	-	-	0,5	40295

RECYFIX®PLUS X 150

RECYFIX®PLUS X 150 - combi article, class D 400

Type 01 with GUGI-ductile iron, mesh grating, cl. D 400, locked, 1 m

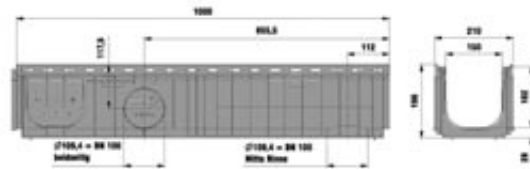
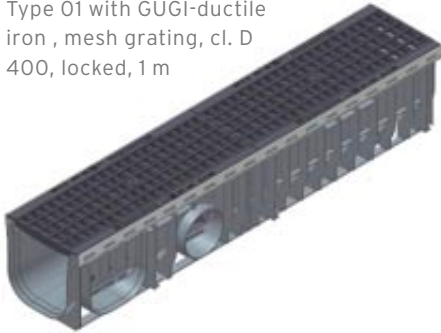

	Length mm	Width mm	Height mm	Drainage cross-sect. cm ²	Intake cross-sect. cm ² /m	Weight kg	Article No.
Type 01 with GUGI-ductile iron, mesh grating, cl. D 400, locked, 1 m	1000	210	196	225	699	15,9	42170

RECYFIX®PLUS X 150 - Accessories



Trash box with GUGI-ductile iron mesh grating, cl. D 400, locked, 0,5 m



Foul air trap DN 100, outside



Foul air trap DN 150



Foul air trap DN 100, inside

	Length mm	Width mm	Height mm	Weight kg	Article No.
Trash box with GUGI-ductile iron mesh grating, cl. D 400, locked, 0,5 m	500	298	504	19,2	42179
Foul air trap DN 100, outside	-	-	-	0,4	961
Foul air trap DN 150	-	-	-	2,0	960
Foul air trap DN 100, inside	-	-	-	0,2	40290
Foul air trap, vertical, DN 100	-	-	-	0,5	40295
End cap galvanised for RECYFIX 150 trash box	-	-	-	0,3	40159
End cap combined made of PE-PP with outlet DN 70/100, Type 01	-	210	202	0,1	40191

RECYFIX®PLUS X 200

RECYFIX®PLUS X 200 - combi article, class D 400

Type 010 with GUGI-ductile iron mesh grating, cl. D 400, locked, 1 m

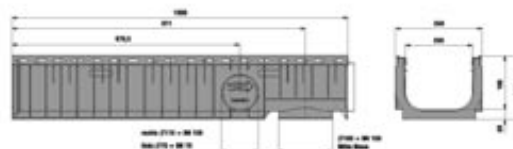
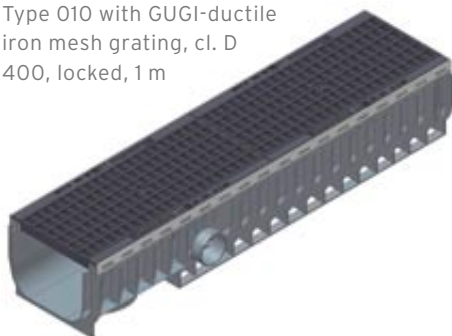

	Length mm	Width mm	Height mm	Drainage cross- sect. cm ²	Intake cross- sect. cm ² /m	Weight kg	Article No.
Type 010 with GUGI-ductile iron mesh grating, cl. D 400, locked, 1 m	1000	260	188	290	878	20,9	42275
Type 020 with GUGI-ductile iron mesh grating, cl. D 400, locked, 1 m	160	1000	238	366	878	21,0	42280

RECYFIX®PLUS X 200 - Accessories



Trash box with GUGI-ductile iron mesh grating, cl. D 400, locked, 0,5 m

	Length mm	Width mm	Height mm	Weight kg	Article No.
Trash box with GUGI-ductile iron mesh grating, cl. D 400, locked, 0,5 m	500	344	738	33,7	42253
Foul air trap, vertical, DN 100	-	-	-	0,5	40295
End cap galvanised for RECYFIX 200 trash box	-	-	-	0,6	40659
End cap combined made of PE-PP with outlet DN 70, Type 010	-	258	185	0,2	40692

RECYFIX®PLUS X 300

RECYFIX®PLUS X 300 - combi article, class D 400

Type 01 with ductile iron grating, cl. D 400 and locking device

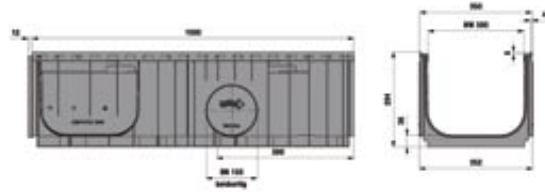

	Length mm	Width mm	Height mm	Drainage cross- sect. cm ²	Intake cross- sect. cm ² /m	Weight kg	Article No.
Type 01 with ductile iron grating, cl. D 400 and locking device	1000	350	294	730	1256	32,0	42375